

ENGLISH

User manual



TABLE OF CONTENTS

1. PRECAUTIONS AND SAFETY MEASURES	2
1.1. During use	2
1.2. After use	2
2. GENERAL DESCRIPTION	3
3. PREPARATION FOR USE	4
3.1. Initial checks	4
3.2. Instrument power supply	4
3.3. Storage	4
4. NOMENCLATURE	5
4.1. Description of the instrument	5
4.2. Description of function keys	6
4.2.1. Key ESC/⏻	6
4.2.2. Key OK/☰	6
4.2.3. Keys ▲ and ▼	6
4.2.4. T key (Trigger)	6
5. OPERATING INSTRUCTIONS	7
5.1. Description of the symbols shown on the display	7
5.2. Description of the general menu	8
5.3. Use of the thermal camera	14
5.3.1. Use of Screening mode for human body temperature measurement	16
5.3.2. Bluetooth connection and use of the APP HTMercury	17
5.3.3. Manual/Automatic measuring modes	18
6. MAINTENANCE	19
6.1. Recharging the internal battery	19
6.2. Cleaning the instrument	19
6.3. End of life	19
7. TECHNICAL SPECIFICATIONS	20
7.1. Environmental conditions for use	21
7.2. Accessories	21
7.2.1. Accessories provided	21
8. ASSISTANCE	22
8.1. Warranty conditions	22
8.2. Assistance	22

1. PRECAUTIONS AND SAFETY MEASURES

The instrument has been designed in compliance with the directives relevant to electronic measuring instruments. For your safety and in order to prevent damaging the instrument, please carefully follow the procedures described in this manual and read all notes preceded by symbol  with the utmost attention. Before and after carrying out the measurements, carefully observe the following instructions:



CAUTION

- Do not carry out any measurements in case gas, explosive materials or flammables are present, or in humid or dusty environments.
- Do not carry out any measurement in case you find anomalies in the instrument such as deformation, breaks, substance leaks, absence of display on the screen, etc.
- Keep the instrument steady during any measuring operation.
- Do not carry out any measurements which exceed the working and storage temperature ranges specified in § 7.1
- Only the accessories provided together with the instrument will guarantee safety standards. They must be used only if in good conditions and replaced with identical models, when necessary.
- Check that the battery is correctly inserted.
- Check that the LCD display gives indications consistent with the function selected.
- Do not direct the instrument at very high intensity radiation sources (e.g. the sun) in order to prevent damaging the IR sensor.
- Prevent hits or strong vibrations in order to keep the instrument from damage.
- **When bringing the instrument from a cold to a hot environment, leave it on long enough for condensation water to evaporate.**

In this manual, and on the instrument, the following symbols are used:



Warning: observe the instructions given in this manual; improper use could damage the instrument or its components.



Compliant with European Standards

1.1. DURING USE

Please carefully read the following recommendations and instructions:



CAUTION

- Failure to comply with the caution notes and/or instructions may damage the instrument and/or its components or be a source of danger for the operator.
- Use the instrument only in the temperature ranges indicated in § 7.1

1.2. AFTER USE

When measurement is complete, switch off the instrument.

2. GENERAL DESCRIPTION

The instrument is a digital thermal camera capable of carrying out infrared temperature measurements of objects and providing thermographic images. It is also very easy to use and needs little maintenance.

The main characteristics of the instrument are:

- Infrared temperature measurement ranging from -20°C to 380°C
- 3 measuring cursors (central steady + hot spot + cold spot)
- Emissivity of materials which can be selected between 0.01 and 1.00
- Image frequency: 50Hz
- 5 selectable color palettes
- Automatic detection of hot/cold spots of the image
- “Screening” function for human body temperature measurement
- Internal memory for image saving
- IR sensor resolution: 80x80pxl
- Bluetooth connection BLE 4.0 to mobile devices through the APP **HTMercury**
- Visible and acoustic alarm condition
- USB port for battery recharge
- Rechargeable Li-ION battery

Some applications of the digital thermal camera are:

- Predictive and preventive maintenance of electrical and mechanical appliances
- Monitoring of the temperature of working processes
- Maintenance and troubleshooting on forced ventilation ducts
- Domestic/industrial use in troubleshooting room insulation problems
- Safety problems

3. PREPARATION FOR USE

3.1. INITIAL CHECKS

Before shipping, the instrument has been checked from an electric as well as mechanical point of view. All possible precautions have been taken so that the instrument is delivered undamaged. However, we recommend generally checking the instrument in order to detect possible damage suffered during transport. In case anomalies are found, immediately contact the forwarding agent. We also recommend checking that the packaging contains all components indicated in § 7.2.1. In case of discrepancy, please contact the Dealer. In case the instrument should be returned, please follow the instructions given in § 8

3.2. INSTRUMENT POWER SUPPLY

The instrument is supplied by 1x3.7V rechargeable Li-ION battery. This battery is built in and **cannot be replaced by the user**. When the battery is flat, the symbol  appears on the display. For battery recharge, please refer to § 6.1.

3.3. STORAGE

In order to guarantee precise measurement, after a long storage time, wait for the instrument to come back to normal condition (see § 7.1).

4. NOMENCLATURE

4.1. DESCRIPTION OF THE INSTRUMENT

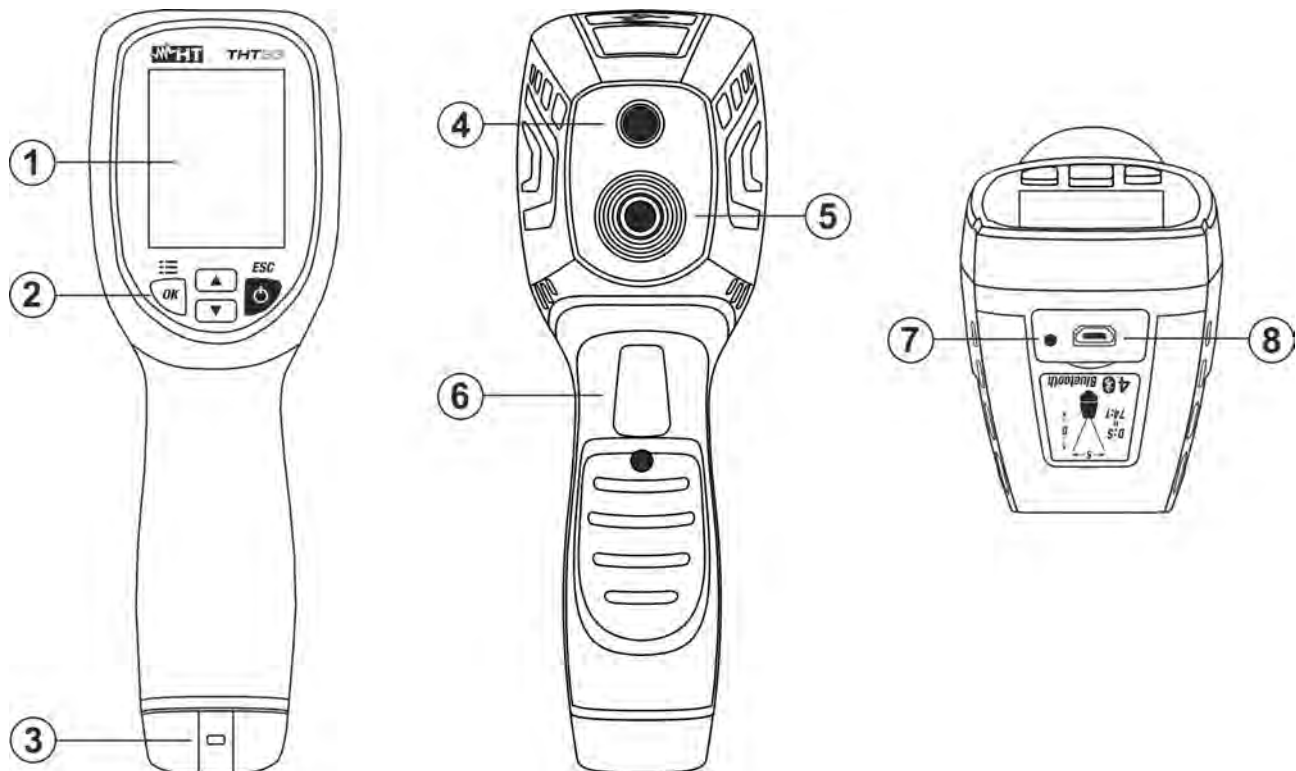





Fig. 1: Description of the instrument

CAPTION:

1	LCD display
2	Function keys OK /  ,  ,  , ESC / 
3	Holes for non-slip strap
4	Built-in illuminator (not available function)
5	IR sensor
6	Trigger key (T)
7	Battery charge indicator LED
8	Micro USB port for battery recharge

4.2. DESCRIPTION OF FUNCTION KEYS

The instrument has 4 function keys indicated as **OK/☰**, **▲**, **▼**, **ESC/⏻** and a trigger key **T** with multiple functions.

4.2.1. Key ESC/⏻

Pressing key **ESC/⏻** allows for the following operations:

- Press and hold (>2s) the key to switch on/off the instrument. The initial screen (see Fig. 2) is shown on the display for approx. 5s; subsequently, the normal measuring screen appears.
- With the instrument switched on, it allows activating/deactivating the Automatic/Manual operating mode (see § 5.3.3).
- With the instrument within the general menu (see § 5.2), it allows quitting and going back to the previous screen, or to the normal measuring screen.



Fig. 2: Instrument's initial screen

CAUTION



- The instrument does not need any manual focusing of the image of the framed item; the image is automatically adjusted.
- The instrument periodically gives out a short sound during its normal operation, when image can freeze for a few moments, in order to eliminate offset errors (internal autocalibration). The noise produced by the commutation of internal parts is not to be considered as a problem
- **After switching on, wait at least 15 minutes before using the instrument for proper internal heating**

4.2.2. Key OK/☰

Pressing key **OK/☰** allows for the following operations:

- Entering the instrument's general menu (see § 5.2) and confirming the values of the programming parameters.
- Saving an image in the internal memory (see § 5.2).

4.2.3. Keys ▲ and ▼

The arrow keys **▲** and **▼** are used for the selection of parameters within the general menu and for their programming.

4.2.4. T key (Trigger)

Pressing key **T** allows for the following operations:

- Activating/deactivating image freezing on the display (snapshot). The message **"Hold"** is shown on the display.
- Deleting the image recalled on the display (see § 5.3).

5. OPERATING INSTRUCTIONS

5.1. DESCRIPTION OF THE SYMBOLS SHOWN ON THE DISPLAY

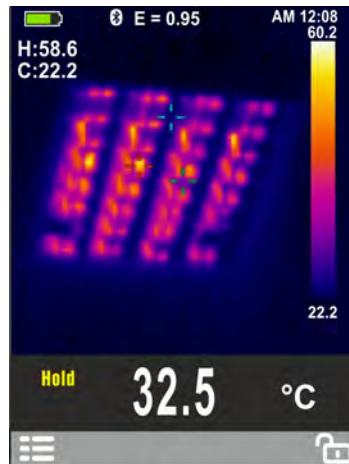



Fig. 3: Symbols on the display

Symbol	Description
E=0.95	Set value of object emissivity
°C, °F, K	Indication of the temperature measuring unit
	Indication of central fixed cursor
	Indication of cursor in the hottest spot of the image (Hot)
	Indication of cursor in the coldest spot of the image (Hot)
32.5	Indication of the temperature associated with the central steady cursor
H	Indication of the temperature of the hottest spot (Hot) of the image
C	Indication of the temperature of the coldest spot (Cold) of the image
22.2, 60.2	Indication of temperature levels of the IR image
12:08	Indication of system time
AM	Indication of system time in the 12 hours format
	Indication of active colour palette
	Indication of active Bluetooth connection
Hold	Symbol of active HOLD function
	Symbol of access to general menu
	Symbol of active Automatic mode
	Symbol of active Manual mode
	Symbol of full battery
	Symbol of flat battery
	Symbol of charging battery in progress

Table 1: Description of the symbols shown on the display

5.2. DESCRIPTION OF THE GENERAL MENU

1. Press key **OK**/ to access the instrument's general menu

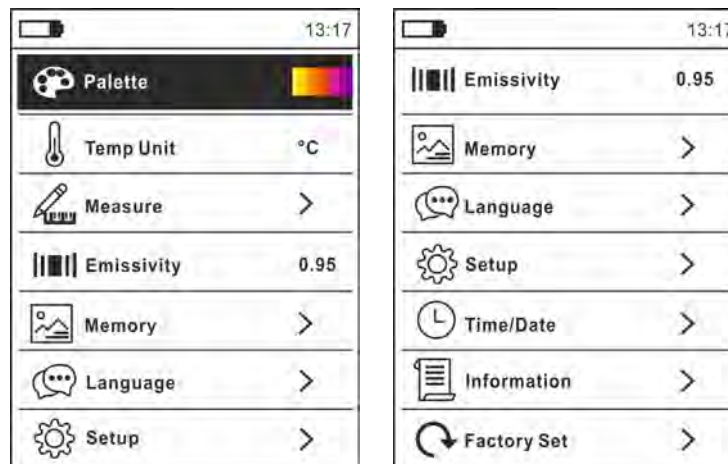

Fig. 4: General menu of the instrument

2. Use the arrow keys **▲** or **▼** to select menu items, and keys **OK** and **ESC** to select parameters and enter/quit internal subsections.

Command Palette

3. Select item "Palette" and press key **OK** to choose the color palette to be used among the options: **Iron, Rainbow, Grey, Reverse Grey, Feather**
4. Press key **ESC** to confirm and quit the general menu

Command Temp Unit

5. Select item "Temp Unit" and press key **OK** to enable the selection of the measuring unit of temperature to be used in Thermal camera mode and for measuring Temperature with K-type probe (parameter is highlighted in grey).
6. Use arrow keys **▲** or **▼** to select options: **°C** (Celsius), **°F** (Fahrenheit) or **K** (Kelvin).
7. Press key **ESC** to confirm and quit the general menu.

Command Measurement

8. Select item "Measurement" and press key **OK**. The followed options are available:
 - **Screening Mode** → to enable the activation/deactivation of the "Screening" mode in order to perform human body temperature measurement
 - **Alarm Temp.** → allows to set the maximum temperature threshold beyond which an alarm condition is shown at display (see § 5.3.1)
 - **Temp. Comp.** → allows to set a possible temperature compensation, added or subtracted, to the value measured by the instrument in the Screening mode
 - **Center Spot** → to enable the activation/deactivation of the fixed cursor in the central position of the thermographic image shown at display
 - **Temp Max** → to enable the activation/deactivation of the cursors associated with the "hottest" spot in the thermographic image
 - **Temp Min** → to enable the activation/deactivation of the cursors associated with the "coldest" spot in the thermographic image

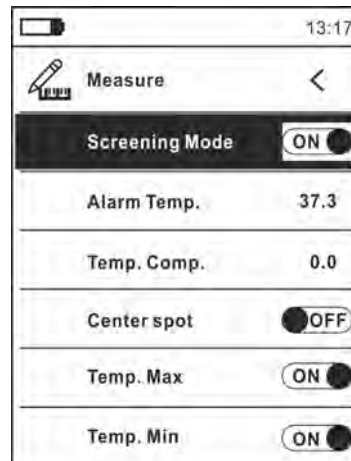

Fig. 5: Measurement Menu

9. Press key **ESC** to confirm and quit the general menu.

Command Emissivity

10. Select item “Emissivity” and press key **OK** to set the value of parameter Emissivity.

11. Use the arrow keys **▲** or **▼** to select the value within range: **0.01 ÷ 1.00**

12. Press key **ESC** to confirm and quit the general menu.

Command Memory (recalling, deleting and sharing images)

13. Select item “Memory” and press key **☰** or **▶** to access the instrument’s internal memory in which it is possible to recall and delete saved images. The following screen appears on the display:

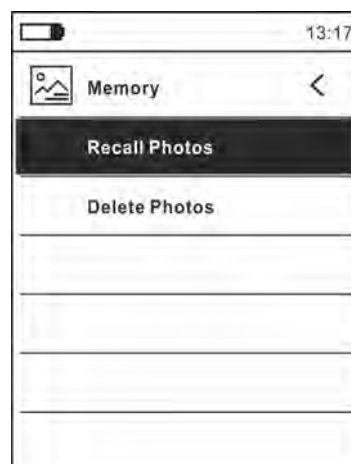

Fig. 6: Menu Memory

14. Use the keys **▲** or **▼** and key **OK** to select option “Recall photo”. The screen in Fig.7 – left side (corresponding to the last saved image) is shown on the display:

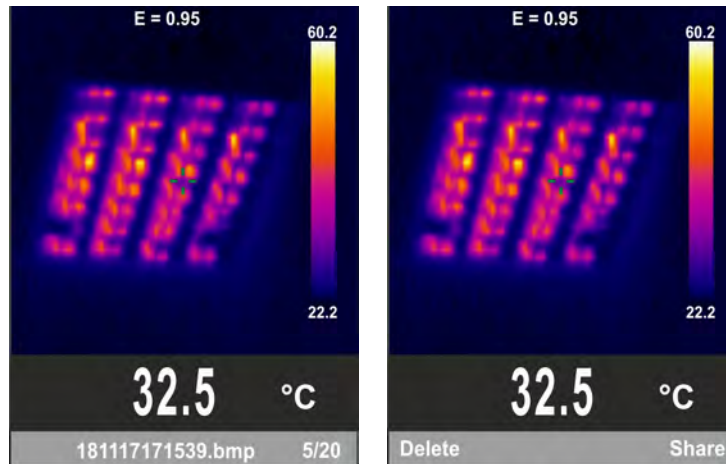

Fig. 7: Recalling, deleting and sharing the image on the display

15. Use the arrow keys ▲ or ▼ to display the desired image among those saved in the instrument's internal memory (max 20 images). The saved image is always in format "YMMDDHHMMSS.bmp", which indicates precisely when the image was saved.
16. To delete the image, press the trigger key **T** on the recalled image. The screen in Fig.7 – right side appears on the display. Press key **T** again to exit the function.
17. Press key **OK** to delete the image or key **ESC** to select the option "Share" in order to share the image on a mobile device through the APP HTMercury and via Bluetooth connection (see § 5.3.1).
18. Use the keys ▲ or ▼ and key **OK** to select option "Delete photo" (see Fig. 6). The following screen appears on the display:

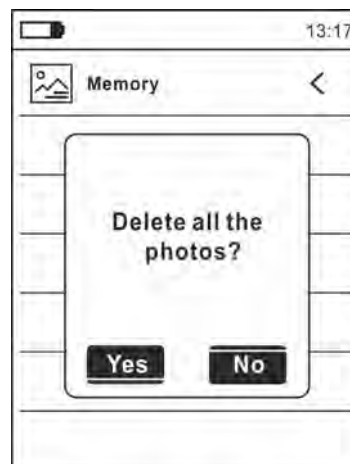

Fig. 8: Deleting all saved images

19. Use the keys ▲ or ▼ to confirm (Yes) or cancel (No) deletion of all saved images.
20. Press key **OK** to confirm and key **ESC** to quit the general menu.

Command Language

21. Select item "Language" and press key **OK** to enable language selection.
22. Use arrow keys ▲ or ▼ to select the language among the available options.



Fig. 9: Language Menu

23. Press key **OK** to confirm and key **ESC** to quit the general menu.

Command Settings

24. Select item "Settings" and press key **OK** to display system settings. The following screen appears on the display:



Fig. 10: Settings Menu

25. Use the arrow keys **▲** or **▼** and key **OK** to select the following options:

- **Bluetooth** → activation/deactivation of Bluetooth connection (see § 5.3.1).
- **Brightness** → setting of the contract level of the display.
- **Auto Power OFF** → deactivation (**OFF**) and activation (**15min, 30min, 60min**) of the instrument's Auto power OFF function.

26. Press key **OK** to confirm and key **ESC** to quit the general menu.

Command Date/Time

27. Select item "Date/Time" and press key **OK** to set system date/time. The following screen appears on the display.



Fig. 11: Date/time Menu

28. Use keys ▲ or ▼ and key **OK** to select/set date/time in the following formats:

- **European** → option **24h** (ON)
- **American (AM/PM)** → option **24h** (OFF)

29. Press key **OK** to confirm and key **ESC** to quit the general menu.

Command Information

30. Select item “Information” and press key **OK** to display information about the instrument (Hardware and Firmware version).



Fig. 12: Menu Information

31. Press key **ESC** to quit the general menu.

Command Factory Set

32. Select item “Factory Set.” and press key ≡ or ► to restore the instrument’s default settings.

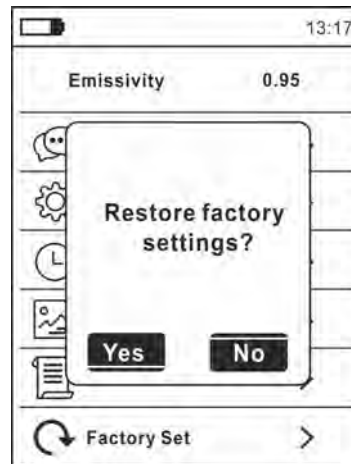

Fig. 13: Default settings reset screen

33. Use the arrow keys ▲ or ▼ and key **OK** to confirm (Yes) or cancel (No) the reset operation.
34. Press key **ESC** to quit the general menu.
35. **The operation does not delete the images saved in the internal memory.**

5.3. USE OF THE THERMAL CAMERA

1. Switch on the instrument by pressing and holding key for approx. 2s.
2. Press key **OK** to enter the general menu to set the emissivity value of the object to be tested and to activate - if necessary - measuring spots H (hot spot) and C (cold spot).
3. Select automatic or manual measuring mode (see § 5.3.3).
4. Frame the object to be tested, whose thermographic image will be displayed (see § 5.1) with automatic focusing.
5. In the thermographic image measuring spots H and C are respectively indicated with red and blue cross pointers.
6. For accurate temperature measurements, make sure the surface of the measured object is always bigger than the surface measurable by the instrument, which is given by the instruments field of view (FOV). The instrument has a field of view of $21^\circ \times 21^\circ$ and a detection vector of 80×80 (6400) pxl, as described in Fig. 14

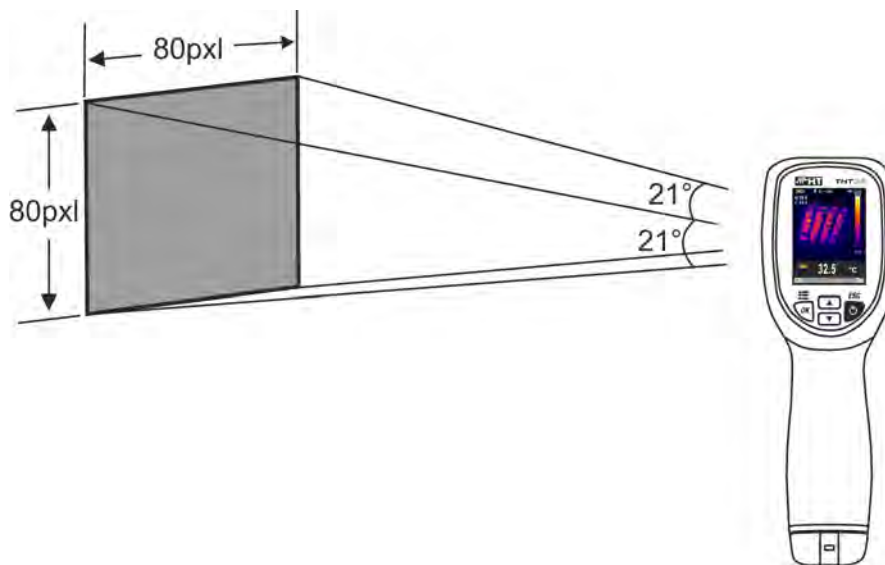

Fig. 14: Representation of the instruments field of view (FOV)

7. The representation of the ratio D (distance from the object) / S (surface of the object) for an instrument provided with 7.5mm lens is described below.

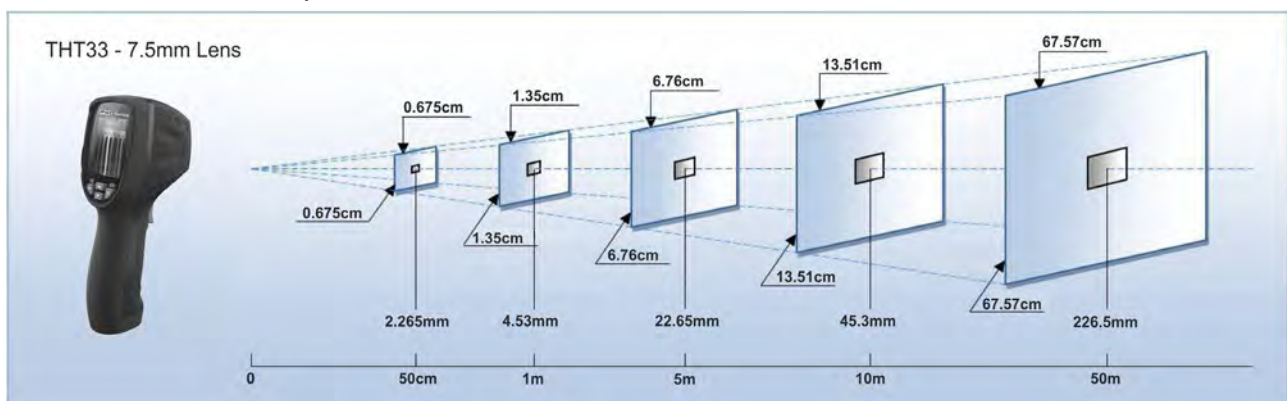

Fig. 15: Representation of the instrument's D/S ratio

In the representation, it is possible to see how the IFOV (Instant Field Of View = geometrical resolution of the instrument = size of the single pxl of the IR sensor) is equal to 4.53mm at a distance of 1m of the instrument from the object being measured. This means that the instrument is capable of carrying out correct temperature measurements at a distance of 1m on objects with a size not lower than 4.53mm

8. Press the trigger key **T** to freeze the screen on the display. Message “HOLD” appears on the display, together with keys **Save** and **Share** (see Fig. 16 – right side).

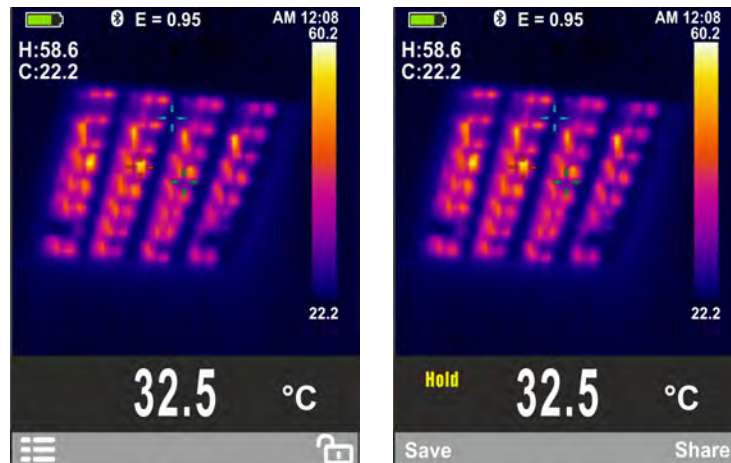

Fig. 16: Saving IR images

9. Press key **Save** to save the image in the instrument's internal memory (see § 5.2) in BMP format or key **T** again to quit the function.
10. Enter the General menu to display the saved result (see Fig. 17 – left side)

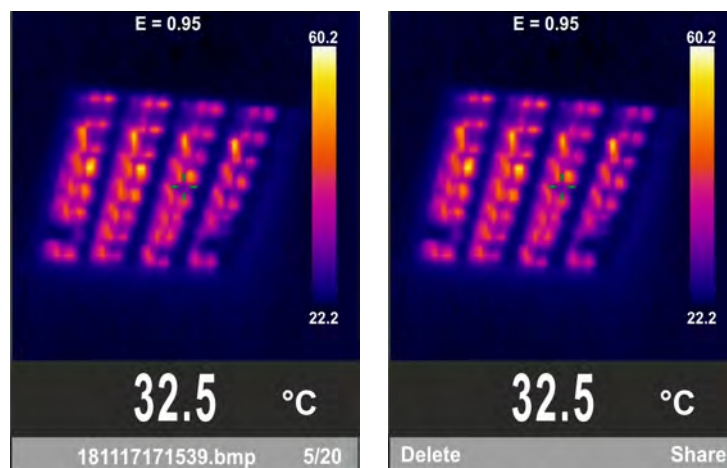

Fig. 17: Recalling and deleting IR images

11. Press key **T** to enter the section to delete the image, see Fig. 17 – right side) and select option “Delete” to delete the image with no confirmation message, or press key **ESC** to go back to the measuring screen.
12. Select the option “Share” in order to transfer the image on a mobile device through the APP **HTMercury** and via Bluetooth connection (see § 5.3.1).

5.3.1. Use of Screening mode for human body temperature measurement



CAUTION

In order to avoid reading errors due to the influence of the external temperature, **it is recommended** to perform the measurement with Screening mode in **indoor environment**

1. Switch on the instrument and wait at least 15 minutes the warm up at room temperature
2. Press key **OK** to enter the general menu
3. Set the emissivity parameter to a value between **0.95** and **0.98** (typically 0.95)
4. Select the "Screening" mode, set the alarm temperature threshold and activate the visualization of the "S" (fixed central spot) cursor on the display inside the "Measure" menu (see § 5.2 – Fig.5)
5. Select the desired color palette (suggested Iron or Grey – see § 5.2)
6. Select automatic measuring mode (see § 5.3.3).
7. Frame the subject on test at a **maximum distance of 20cm**. With temperature of the subject higher than the set alarm threshold value, the instrument shows the value associated with the cursor "S" in red color in the lower part of the display (see Fig. 18 – left part) and a continuous beep is emitted by the instrument

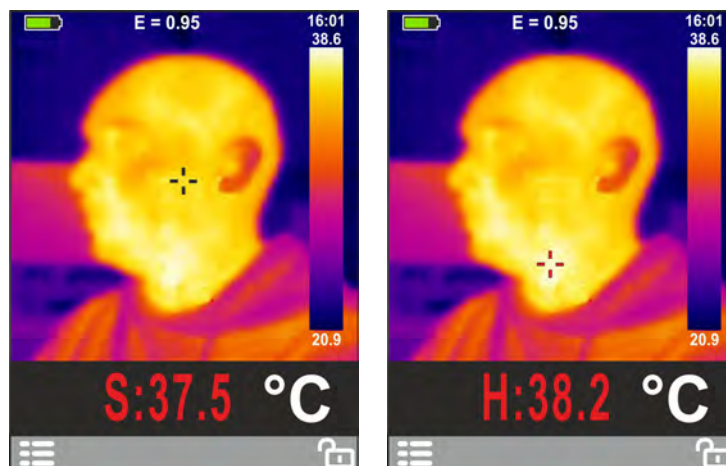

Fig. 18: Visualization of alarm condition in Screening function

8. With activation of the "H" cursor (hottest point) the instrument always shows as priority the point with maximum temperature of the framed image. If this value is higher than the set alarm threshold it will be shown in red color in the lower part of the display (see Fig. 18 – right part) and a continuous beep is emitted by the instrument
9. For the saving of the image see § 5.3



CAUTION

- The Screening function allows measuring the temperature of the human body, but the instrument **CAN IN NO WAY be used as a medical device.**
- Temperature measurement with the Screening function **cannot replace medical evaluation.**

5.3.2. Bluetooth connection and use of the APP HTMercury

1. Press key , select menu "Settings" and activate the Bluetooth connection on the instrument (see § 5.2) as shown in Fig. 19

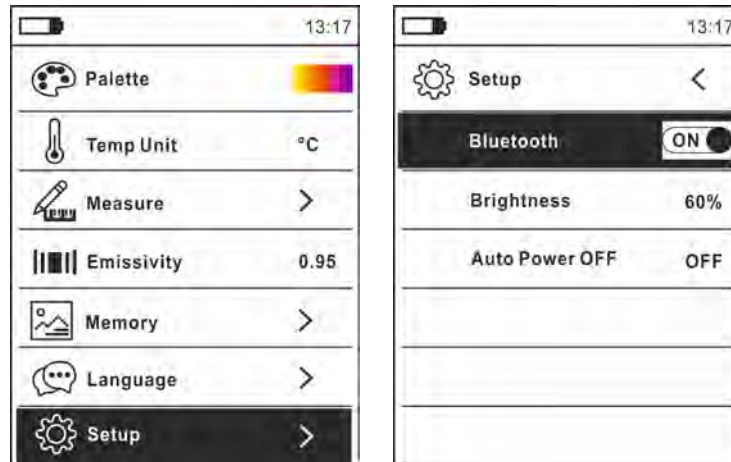

Fig. 19: Activation of Bluetooth connection

2. Download the APP **HTMercury** free from Android and iOS stores and install it on the mobile device (tablet/smartphone).
3. Activate the Bluetooth connection on the mobile device and launch the APP HTMercury
4. Search for the instrument in the APP (see Fig. 20 – left side).

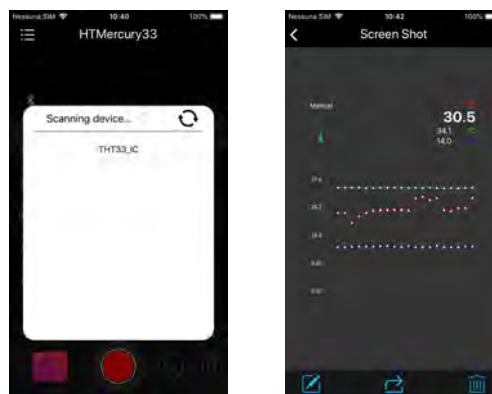

Fig. 20: Communication with the APP HTMercury

5. Real-time display of temperatures (central spot, hottest spot, coldest spot) of the image is available on the mobile device (see Fig. 20 – right side) and it is possible to save the screens from the APP's internal menus. It is also possible to save screens of thermographic images (see Fig.20) and insert items onto them for advanced analyses (see the Help on line of the APP for further details)

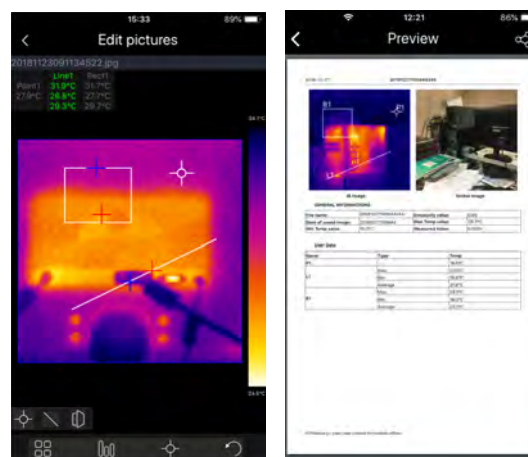

Fig. 21: Applications of the APP HTMercury

5.3.3. Manual/Automatic measuring modes

In this section it is possible to define the adjusting mode of the temperature associated with the image framed on the display. The following modes are available:

- **Automatic** → The minimum and maximum temperature levels of the framed object on the display and associated with the colour palette are automatically defined by the instrument and dynamically vary when moving it. This (default) option, which can be used in most cases, allows for an optimum display of the IR image in a condition of temperatures equally distributed within it.
- **Manual** → minimum and maximum temperature levels of the framed object on the display are manually set by the user in a precise way, or taking a screen as a reference. If the temperature of the spot associated with the central cursor is **higher** than the set values, the colour of the object becomes **White**. If the temperature of the spot associated with the central cursor is **lower** than the set values, the colour of the object becomes **Black**. This mode, particularly useful to clearly identify only some areas of the image, is recommended in case of advanced thermographic operations.

To set Manual mode, proceed as follows:

1. Press key **ESC**/ to activate Manual mode. The temperature values stay fixed within a frame with grey background and symbol appears on the display (see Fig.21 – left side).
2. Press key **▲** to set the higher temperature value. The following screen (see Fig.21 – middle) appears on the display.

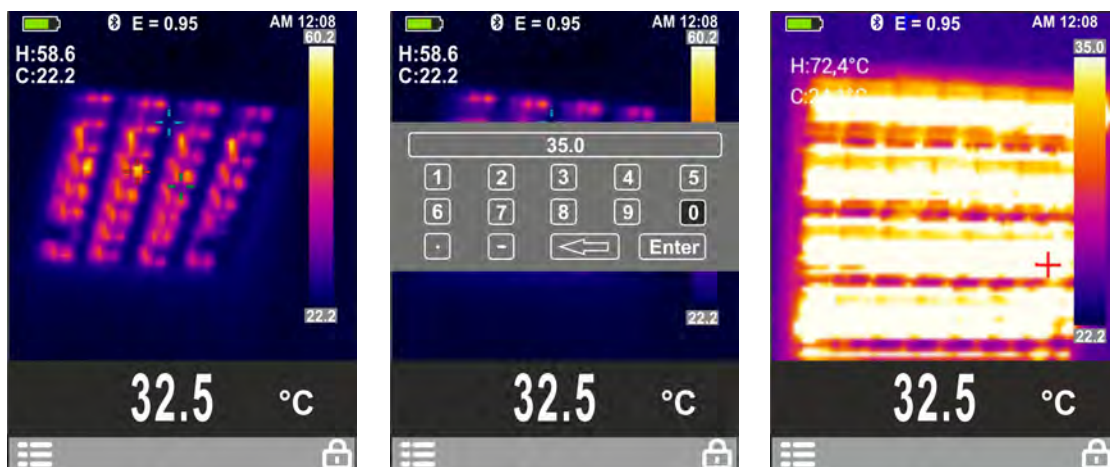

Fig. 22: Image display in Manual mode

3. Use the four keys **OK**, **▲**, **▼**, **ESC** in the virtual keyboard to select the desired numerical value.
4. Select virtual key **←** to delete the value, press key **T** to define each value and select the virtual key **“Enter”** to confirm the value (e.g.: 35.0°C in Fig. 21 – middle) and quit setting section.
5. Press key **▼** to set the lower temperature value by following the same procedure described in 3 and 4.
6. The display of the object in Manual mode is shown in Fig. 21 – right side.
7. Press key **ESC**/ to go back to Automatic mode.

6. MAINTENANCE

6.1. RECHARGING THE INTERNAL BATTERY



CAUTION

- Only expert and trained technicians should perform maintenance operations.
- Do not use the instrument in environments with high humidity levels or high temperatures. Do not expose to direct sunlight.
- **The rechargeable battery is built in the instrument and CANNOT be replaced by the user.**
- **The instrument can be used while battery is recharging**



When the LCD displays symbol  or the below screen:



Fig. 23: Visualization of low battery level

it is necessary to recharge the internal battery.

Recharge via USB cable connected to a PC

1. Connect the provided USB cable to the micro USB input on the instrument (see Fig. 1 – part 8).
2. Wait for the red LED to turn off (see Fig. 1 – part 7) which indicates that the recharging process is complete.
3. By switching on the instrument in these conditions, the recharging symbol “” is shown on the display (see Table 1).

Recharge through external power supply

1. Connect the (provided) USB cable to the external power supply, and the micro USB connector to the input on the instrument (see Fig. 1 – part 8).
2. Connect the power supply to the electric mains.
3. Wait for the red LED to turn off (see Fig. 1 – part 7) which indicates that the recharging process is complete
4. By switching on the instrument in these conditions, the recharging symbol “” is shown on the display (see Table 1)

6.2. CLEANING THE INSTRUMENT

Use a soft and dry cloth to clean the instrument. Never use wet cloths, solvents, water, etc.

6.3. END OF LIFE



WARNING: the symbol on the instrument indicates that the appliance and its accessories must be collected separately and correctly disposed of.

7. TECHNICAL SPECIFICATIONS

Temperature measurement

Range	Resolution	Accuracy (*)
-20°C ÷ 380.0°C	0.1°C	±2%rdg or ±2°C (higher value)
-4.0°F ÷ 716.0°F	0.1°F	±2%rdg or ±3.6°F (higher value)

(*) Accuracy referred to environmental temp. 10°C ÷ 35°C, object temp. >0°C

Temperature measurement in Screening mode

Range	Resolution	Accuracy
32.0°C ÷ 42.0°C	0.1°C	±0.5°C
89.6°F ÷ 107.6°F	0.1°F	±0.9°F

General specifications

Type of IR sensor / Resolution:	UFPA / (80x80pxl, 34µm)
Spectrum response:	8 ÷ 14µm
Visual range (FOV) / Lens:	21° x 21° / 7.5mm
I FOV (@ 1m):	4.53mrad
Thermal sensitivity (NETD):	<0.1°C@30°C
Image frequency:	50Hz
Focusing:	automatic
Minimum focus distance:	0.5m (2ft)
Temperature readings:	°C, °F, K
Available color palettes:	5 (Iron, Rainbow, Grey, Reverse grey, Feather)
Alarm conditions:	visible and acoustic
Emissivity correction:	0.01 ÷ 1.00 in steps of 0.01
Image adjustment mode:	Automatic / Manual
Measuring functions:	correction according to emissivity
Measuring cursors:	3 (Fixed, Max Temp., Min Temp.)
Internal memory:	max 20 locations
Image format:	BMP
Bluetooth interface:	BLE 4.0

Power supply

Internal supply:	rechargeable Li-ION battery, 3.7V 1300mAh
External supply:	adapter 100-240VAC (50/60Hz) / 5VDC
Battery duration:	5 hours (Bluetooth OFF), 4 hours (Bluetooth ON)
Recharging time:	ca 3 hours (adapter), ca 5 hours (USB)

Display

Characteristics:	Color, TFT 2.8", 320x240pxl
------------------	-----------------------------

Mechanical characteristics

Dimensions (L x W x H):	180 x 60 x 75mm (7 x 2 x 3in)
Weight (battery included):	260g (9ounces)
Mechanical protection:	IP54

7.1. ENVIRONMENTAL CONDITIONS FOR USE

Operating temperature:	-10°C ÷ 45°C (14°F ÷ 113°F)
Operating humidity:	<80%RH
Storage temperature:	-20°C ÷ 60°C (-4°F ÷ 140°F)
Storage humidity:	<80%RH
Falling test:	2m (7ft)

**This instrument complies with Directive EMC 2014/35/EU
This instrument satisfies the requirements of European Directive 2011/65/EU (RoHS)
and 2012/19/EU (WEEE)**

7.2. ACCESSORIES

7.2.1. Accessories provided

- Integrated 7.5 mm focal lens
- Built-in rechargeable Li-ION battery
- Adapter AC/DC 100-240V/5V
- USB cable
- Non-slip strap
- ISO9000 calibration certificate
- User manual
- Soft transport bag

8. ASSISTANCE

8.1. WARRANTY CONDITIONS

This instrument is warranted against any material or manufacturing defect, in compliance with the general sales conditions. During the warranty period, defective parts may be replaced. However, the manufacturer reserves the right to repair or replace the product. Should the instrument be returned to the After-sales Service or to a Dealer, transport will be at the Customer's charge. However, shipment will be agreed in advance. A report will always be enclosed to a shipment, stating the reasons for the product's return. Only use original packaging for shipment. Any damage due to the use of non-original packaging material will be charged to the Customer. The manufacturer declines any responsibility for injury to people or damage to property.

The warranty shall not apply in the following cases:

- Repair and/or replacement of accessories and battery (not covered by warranty).
- Repairs that may become necessary as a consequence of an incorrect use of the instrument or due to its use together with non-compatible appliances.
- Repairs that may become necessary as a consequence of improper packaging.
- Repairs which may become necessary as a consequence of interventions performed by unauthorized personnel.
- Modifications to the instrument performed without the manufacturer's explicit authorization.
- Use not provided for in the instrument's specifications or in the instruction manual.

The content of this manual cannot be reproduced in any form without the manufacturer's authorization.

Our products are patented and our trademarks are registered. The manufacturer reserves the right to make changes in the specifications and prices if this is due to improvements in technology.

8.2. ASSISTANCE

If the instrument does not operate properly, before contacting the After-sales Service, please check the condition of the battery. Should the instrument still operate improperly, check that the product is operated according to the instructions given in this manual. Should the instrument be returned to the After-sales Service or to a Dealer, transport will be at the Customer's charge. However, shipment will be agreed in advance. A report will always be enclosed to a shipment, stating the reasons for the product's return. Only use original packaging for shipment; any damage due to the use of non-original packaging material will be charged to the Customer.